

Please note that the data given here has been taken from the online catalog. For comprehensive information and data, please refer to the user documentation at <http://www.download.phoenixcontact.com>. The General Terms and Conditions of Use apply to Internet downloads.

▶ Extract from the online catalog

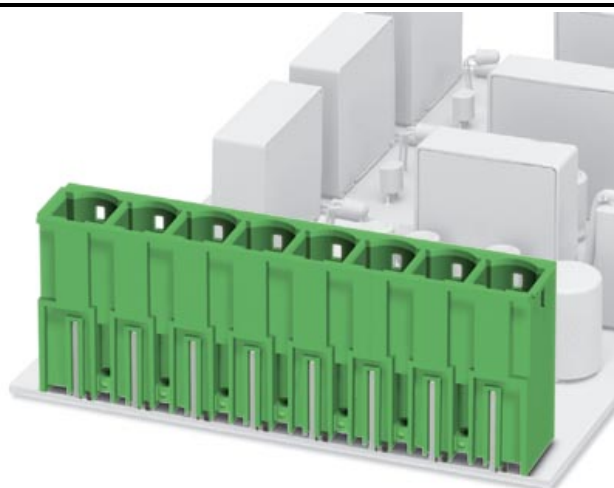

POWER COMBICON headers, 10.16 mm pitch, color: Green, no. of positions: 2

The illustration shows an 8-position version

Order No.	1998784
Ord designation	PCV 6-16/ 2-G1-10,16
EAN	4046356038287
Pack	50 Pcs.
Customs tariff	85369010
Catalog page information	Page 118 (NTK-2005)

▶ Product notes

WEEE/RoHS-compliant since: 05/18/2004



▶ Certificates

CUL	
Nominal voltage U_N	300 V
Nominal current I_N	55 A
Nominal voltage U_N	600 V
Nominal current I_N	5 A

UL

Nominal voltage U_N	300 V
Nominal current I_N	55 A
Nominal voltage U_N	600 V
Nominal current I_N	5 A

► Drawings

Drilling diagram

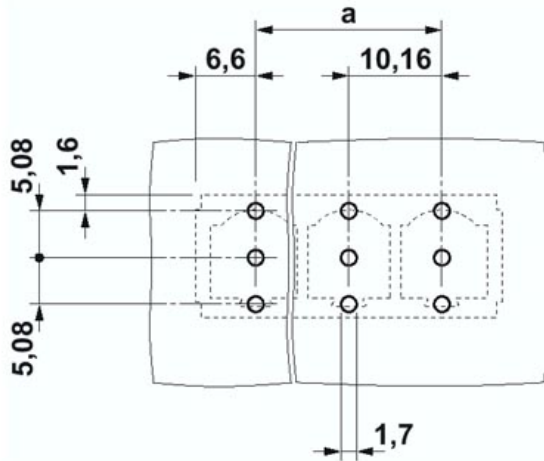

Dimensioned drawing

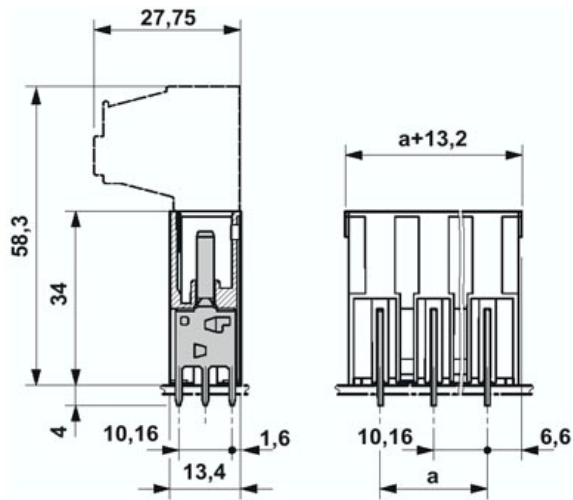

► Accessories

Item	Designation	Description
General		
1970016	CS-IPC 16/ 6	Keying peg, serves to ensure correct polarization on the PCB during manual mounting
Plug/Adapter		
1600027	CP-HCC 4	Coding section, is inserted into the slot on the plug and panel mounting base, red insulating material



► Address

PHOENIX CONTACT Inc., USA
586 Fulling Mill Road
Middletown, PA 17057
USA
Phone (800) 888-7388
Fax (717) 944-1625
<http://www.phoenixcon.com>
Phoenix Contact
Technical modifications reserved;